

\$2.95

• THE VERSA-LOK® •

MOSAIC® FIELD GUIDE

PANELS • PINNING • CORNERS



VERSA-LOK®

Retaining Wall Systems

Solid Solutions.™

The Mosaic® Field Guide is a simple pocket reference for installing VERSA-LOK® Mosaic retaining wall units. For more detailed information on VERSA-LOK wall installations, see *VERSA-LOK Mosaic Design and Installation Guidelines, VLM-602*. Mosaic consists of three VERSA-LOK units: **Standard**, **Accent**®, and **Cobble**®.

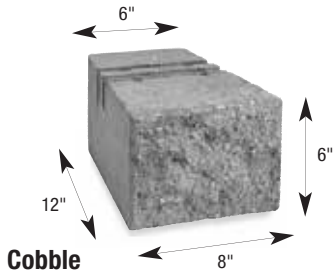
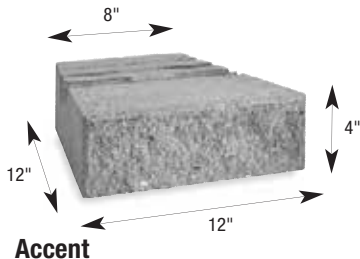
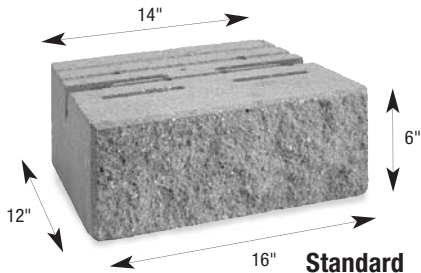

Mosaic® Panels

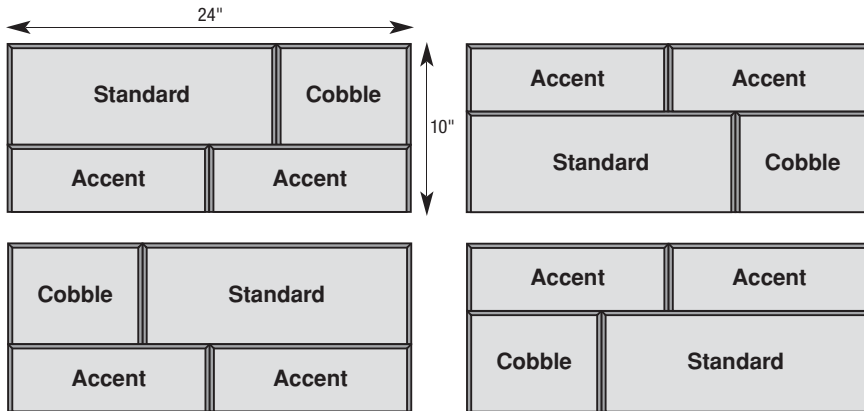

Mix all four panel configurations throughout wall.

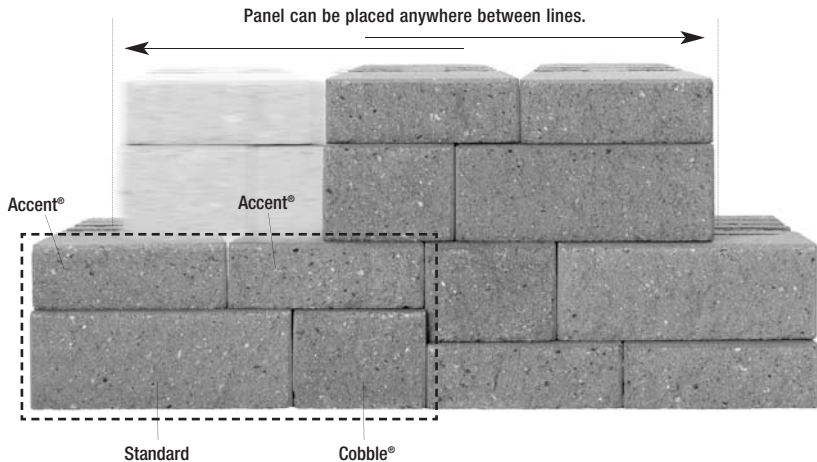

Build a complete panel before starting another.
Randomly change order of Cobble and Standard units.

NO!



No continuous vertical joints.

YES!

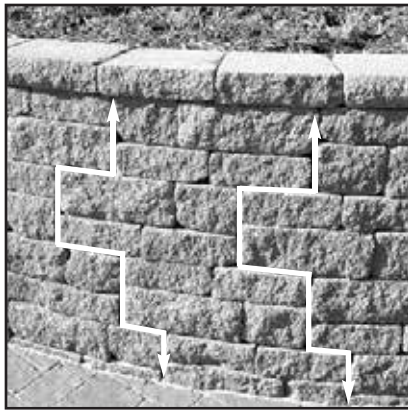

STAGGERING PANELS

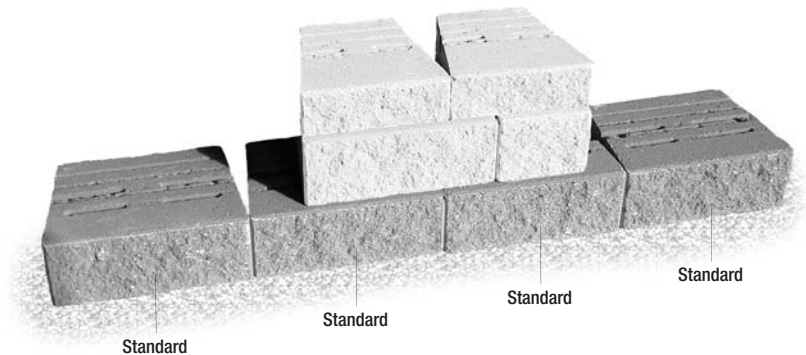

Build base using only Standard units.

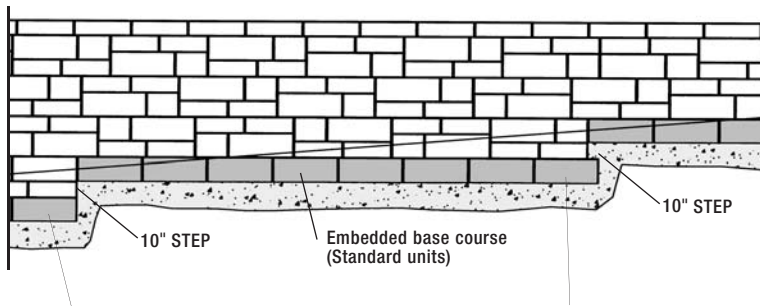

Base is built using all Standard units.

Base is built using all Standard units.

Build base using only Standard units.

Pinning Accent® to Standard/Cobble®

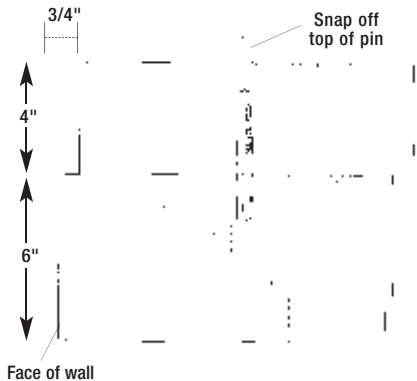

Pinning Standard/Cobble to Accent

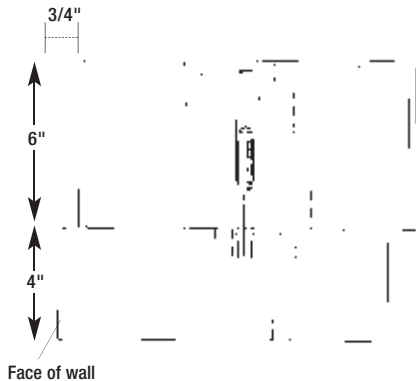



VERSA-TUFF®
Snap-Off Pins



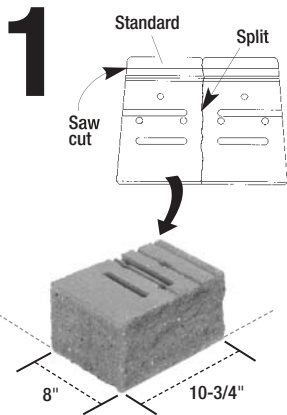

Always start at corners.

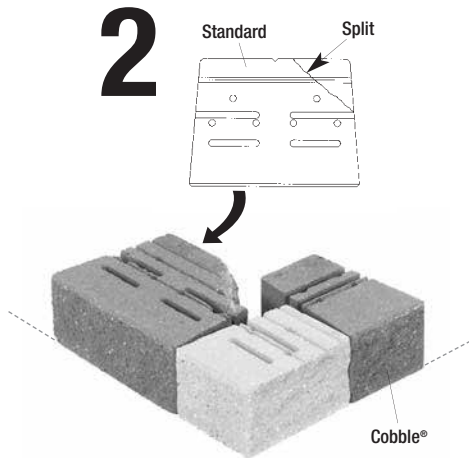

3

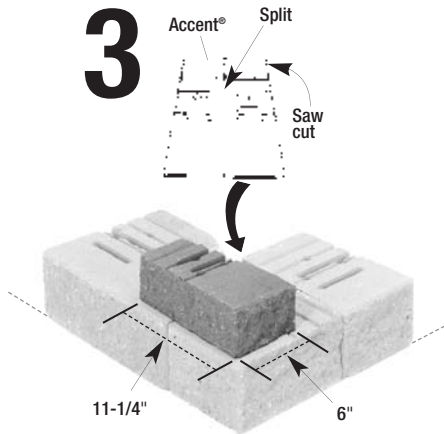

4

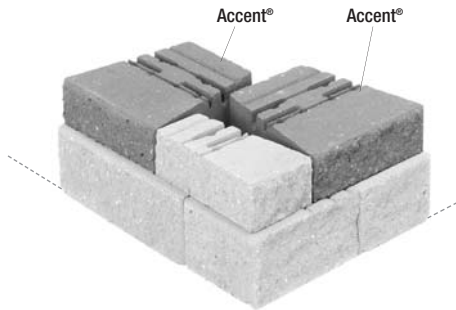

5



Mosaic®
panel

Mosaic®
panel



6

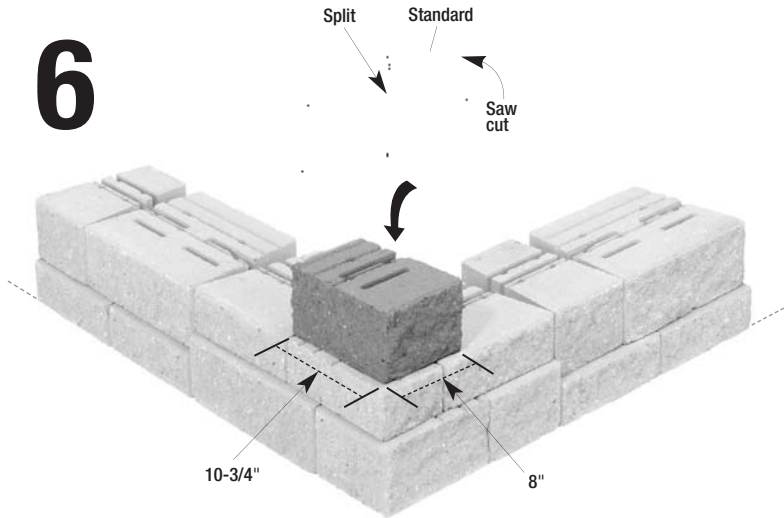

7

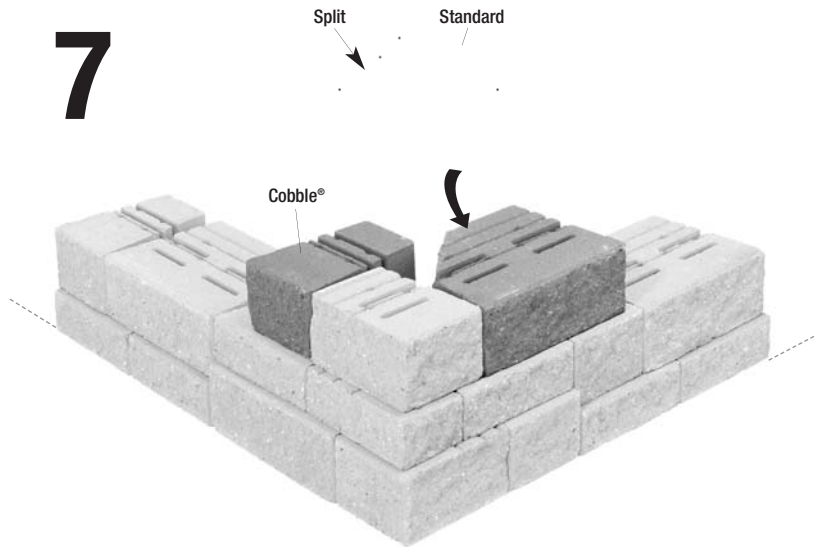

8

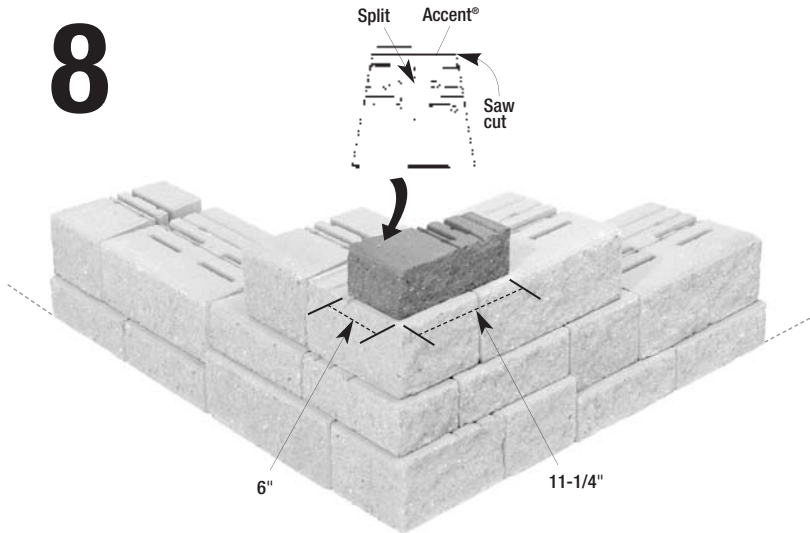

9

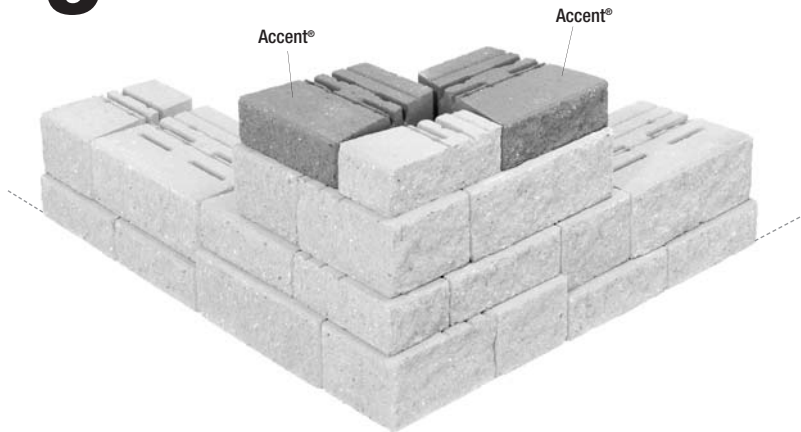

10

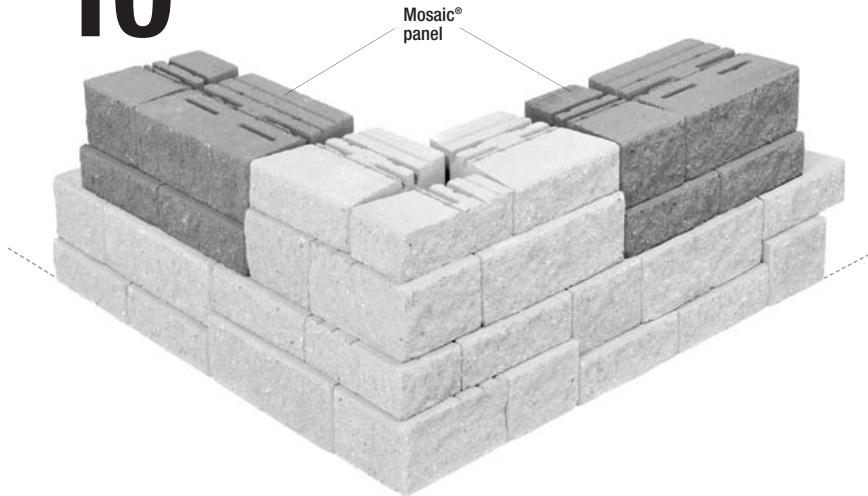

CORNERS—Outside 90°

1

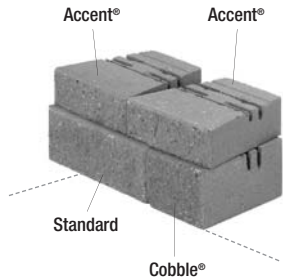

2

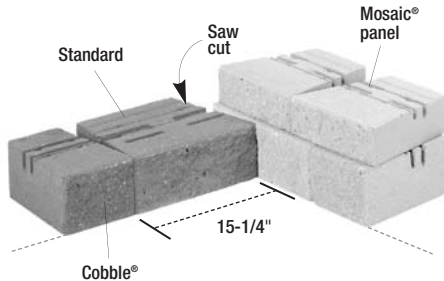

Always start at corners.

3

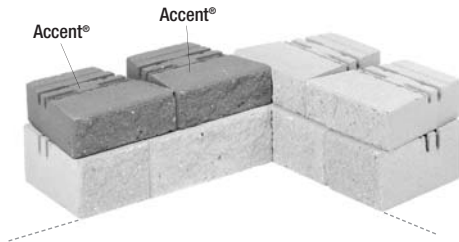

CORNERS—*Inside* 90°

4



5

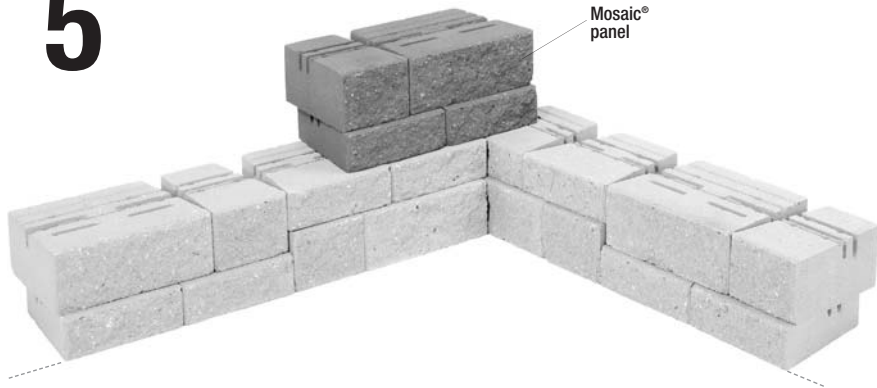

CORNERS—Inside 90°

6

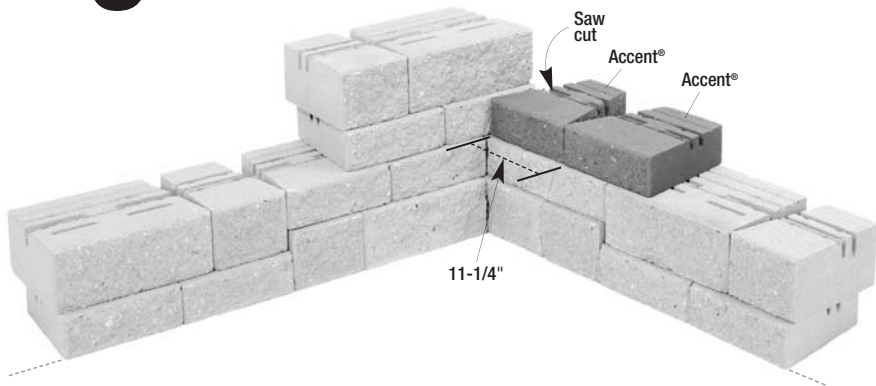

7

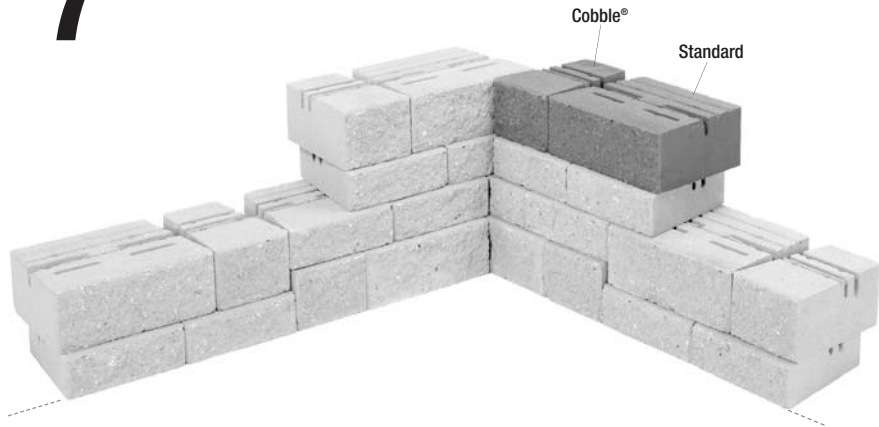

CORNERS—Inside 90°

8

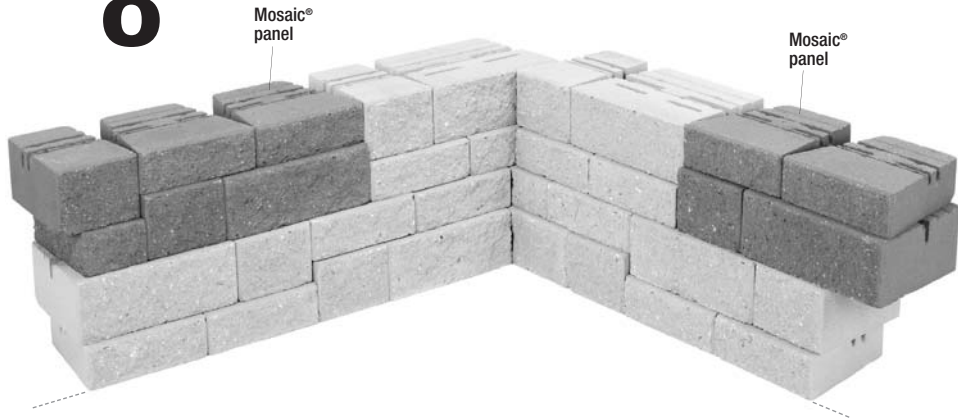

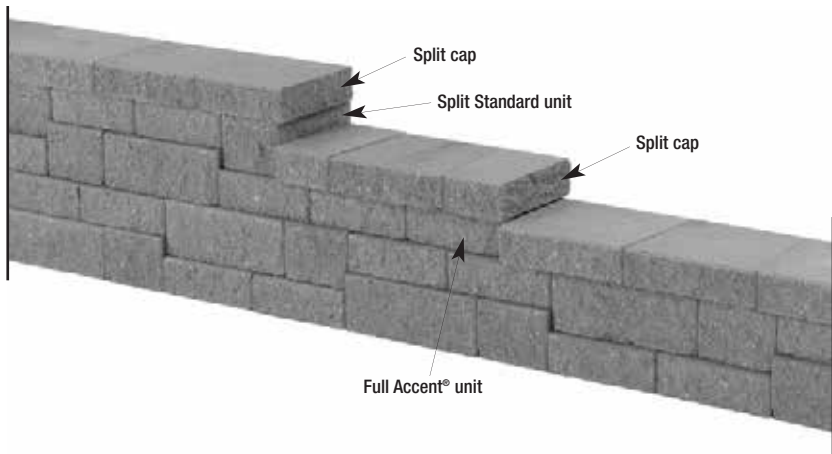

Technical Information

This field guide is intended as a quick reference for unit installation only. For more information regarding other aspects of wall installation, see *VERSA-LOK® Mosaic® Design and Installation Guidelines*. There are many variables to consider when planning or constructing any retaining wall.

Soil types, drainage, loading, topography, and height need to be addressed on each project to ensure safe, trouble-free installation.

Please note the maximum height for an unreinforced Mosaic retaining wall is four feet. Individual site, soil, and loading conditions (including terraces) may limit unreinforced wall heights to less than four feet. Taller walls require soil reinforcement and engineering assistance.

The information, including technical and engineering data, figures, tables, designs, drawings, details, and suggested procedures, presented in this publication is for general information only. While every effort has been made to ensure its accuracy, this information should not be used or relied upon for any application without verification of accuracy, suitability, and applicability for the use contemplated, which is the sole responsibility of the user. A final, project-specific design should be prepared by a qualified, licensed, professional engineer based on actual site conditions. VERSA-LOK® Retaining Wall Systems disclaims any and all express or implied warranties of merchantability fitness for any general or particular purpose, trademark, or copyright in regard to information or products contained or referred to herein.

The following Technical Bulletins were written for use of VERSA-LOK Standard units; however, the general principles apply to Mosaic® walls as well. You can download Technical Bulletins from the VERSA-LOK website at www.versa-lok.com, or call **1-800-770-4525**.

- **Technical Bulletin #1** *Shoreline, Waterway, and Retention Pond Protection*
- **Technical Bulletin #2** *Stairs*
- **Technical Bulletin #3** *Curves and Corners*
- **Technical Bulletin #4** *Caps*
- **Technical Bulletin #5** *Base Installation*
- **Technical Bulletin #6** *Freestanding Walls, Columns, and Vertical Walls*
- **Technical Bulletin #7** *Tiered Walls*
- **Technical Bulletin #8** *Fences, Railings, and Traffic Barriers*

Also available from VERSA-LOK:

- **Design and Installation Guidelines**
- VERSA-LOK Mosaic
- **Technical Documentation for VERSA-Grid® Soil Reinforcement**
- **Standard and Mosaic Construction Details CD-Rom containing drawings created with AutoCAD® software**
AutoCad is a registered trademark of Autodesk, Inc.

\$2.95



VERSA-LOK®
Retaining Wall Systems
Solid Solutions™



Made worldwide under license from VERSA-LOK® Retaining Wall Systems.

U.S. Patent 6,488,448, U.S. Patent D319,885, U.S. Patent D321,060, U.S. Patent D341,215,

U.S. Patent D346,667, U.S. Patent D378,702, U.S. Patent D391,376, U.S. Patent D430,680,

U.S. Patent D435,302, U.S. Patent D452,332 and other U.S. patents pending;

Canadian Industrial Design Registration No. 63929, No. 71472, No. 73910,

No. 73911, No. 73912, No. 77816, No. 79058, No. 82288, and No. 89084.

**A Division of
Kiltie Corporation
6348 Hwy 36, Suite 1
Oakdale, MN 55128**

**(800) 770-4525
(651) 770-3166 *office*
(651) 770-4089 *fax***

© 2003 Kiltie Corporation • Printed in U.S.A. • VLM-604 • 10K • 3-03

www.versa-lok.com